



# Smart ZigBee Wall Switch

## User Manual

3 Gang Switch



5 Gang Switch



6 Gang Switch



Available in Matte White  
and Matte Black Colours

## Features

- 1 High-quality tempered glass panel design.
- 2 With RGB LED indicator, you can change the color by APP.
- 3 Momentary switch function(Dimming the light) Child lock.
- 4 Support 2-5 Way (Via ZigBee Hub).
- 5 Memory the last state.
- 6 Turn on/off backlight Power metering.
- 7 Multiple themes selection (Dark/Light)
- 8 Support Amazon Alexa and Google Assistant ,etc.

## Installation

- 1 Open the front cover by a small flat screwdriver

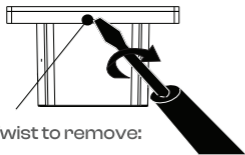

- 2 Or magnetic opening installation

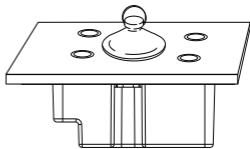

- 3 Wiring diagram Connect wire to the correct terminal and tighten the screws.

## 3 Gang For Example

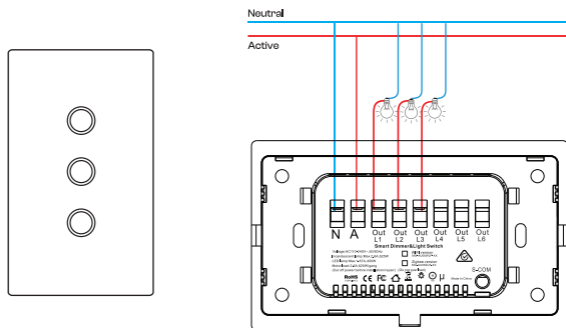

## 4 1 Gang 3 Way Wiring diagram (For example)

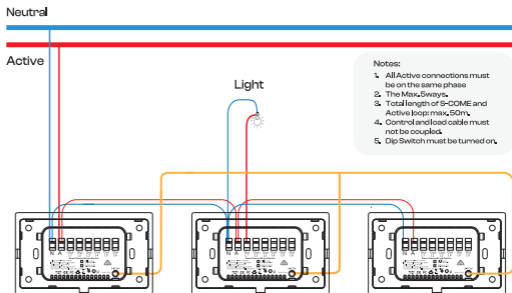

**5 Fix screws**

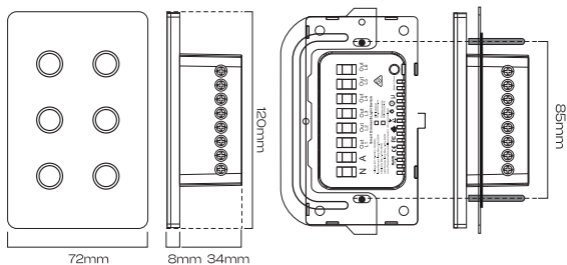

**6 Cover the panel and connect the power.**

- 1 Make sure to use our original screws or use cross shaped flat head screws**
- 2 Do not fix the screws too tight, as tootight will cause the shell to deform and it will not working**
- 3 After the glass panel is covered, please check whether it is tightly attached to the bottom shell. If not, it will not work.**
- 4 Turn on general power**

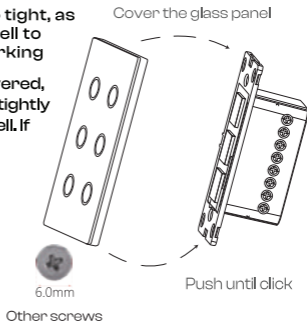

### Attention:

If you perform a touch test without the glass panel cover, please turn off the main power after testing. Then, install the glass panel cover and turn on the main power again.

### How is the DIP switch working

- 1 Pls turn off main power before toggling the DIP switch, settings won't be activated when power is on.
- 2 Up to 5-way switching, the first 6 Gangs compatible with 2 Way by control cable or app association, the remaining by app association.
- 3 Activate 2 Way function when DIP switch is on

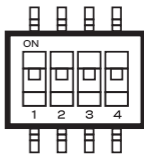

### Connect Your ZigBee Hub

Ensure your ZigBee Hub is connected to the nearest ethernet port with internet access.

### Download & Register the APP

Please download the free app from the App store or Google Play store, or scan the QR code below.



Scan Me



Scan Me



Open the Sparkelec Smart Home app. For new users, register a new account. If you are an existing user, log in with your username and password.

### Add smart switch to your App

- 1 Arrange installation of your smart switch by a licensed electrical contractor (refer installation instructions at start of this manual).
- 2 Once safely wired and powered on, click on/off button five times consecutively and rapidly then hold the button for 5 seconds until the buttons start to blink rapidly.
- 3 Open Sparkelec Smart Home & Choose the relevant product or auto detection

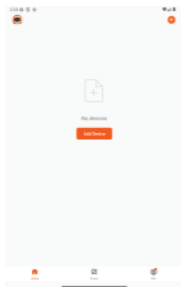

Add the device



Search the device



Find the device

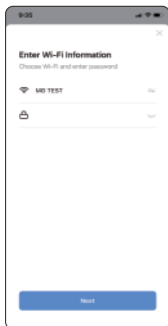

Enter password

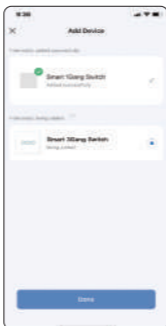

Finished



Turn on/off the switch

## Add Zigbee switch to your App

- 1 Use the cable wire to connect the gateway and router
- 2 Open "Sparkelec Smart Home", click top right "+"
- 3 Choose "Gateway and others" and choose the "gateway" click next until finished



Zigbee gateway

- 4 Press "ⓘ" button 5 seconds, The LED indicator will be flashing. Open "Sparkelec Smart Home", click top right-hand "+", Add "Electrician", choose the "Switch(zigbee)", Click next & choose the gateway, Then step by step until completion. Or choose "Smart Gateway", click "Add subdevice"--" LED already blink, search device, then step by step until finished.



Enter your password



Connection will now begin

Using your “Sparkelec Smart Home” app you can turn this device ON/OFF. Multiple Theme selection (Dark/Light)

Press the Icon Longer to Change

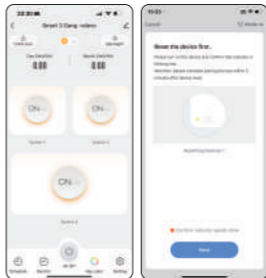

## How does our Dimmer Module Work

Advantage:  
Smart dimmer module control by phone

Neutral

Active

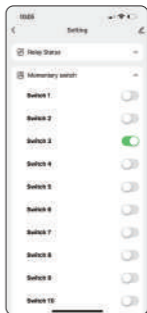
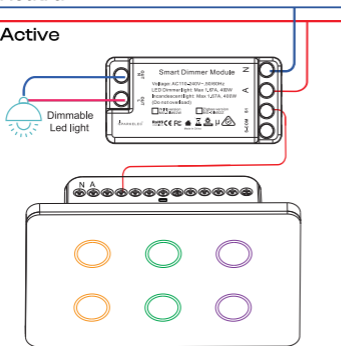

- 1 Smart switch have to connect with the smart dimmer module
- 2 Open the "momentary function" on APP setting
- 3 Touch for ON/OFF, long press for dimming

## Other functions



Adjust RGB backlight



Turn on/off backlight

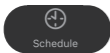

Schedule

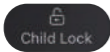

Child lock



Multiple Themes  
selection (Dark/Light)

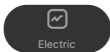

Electric

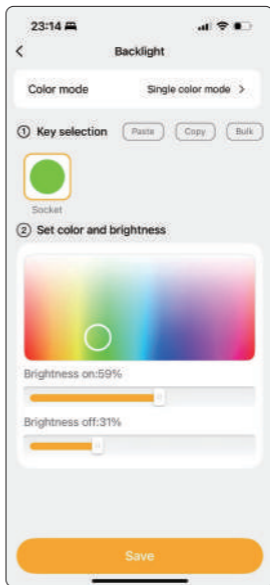

## Power metering function

### Electric stats

This allows you to monitor the power usage of connected loads (current, power, voltage and kWh)

The values show are the total of all gangs per wall plate. These values are for reference only.



## Setting 2 Way or 4 Way

Open Sparkelec Smart Home App go to "Profile"

Click "Multi-Control Association"

Click "+Link with Switch" to association

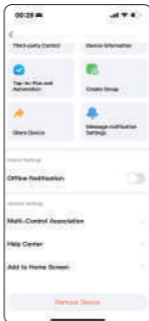

## How to connect Alexa and Google Assistant

Add the Smart Switch to Alexa/Google Assistant following this instructions below: Open Sparkelec Smart Home App, go to "Profile" -> "Integration, tap "Alexa" or "Google Assistant" and install



1.Third-party Control

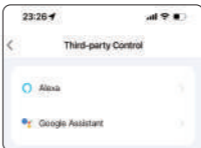

2. Choose Alexa



3. Link to Alexa

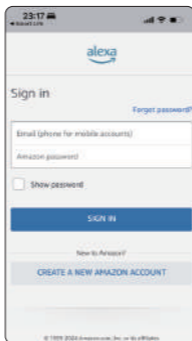

4. Enter account

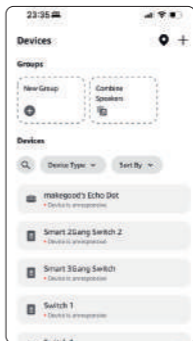

5. Devices list

## Specification

Dimension	Voltage
120*72*42mm or 124*78*43,5mm	110-240V AC/50~60Hz
Fluorescent Lamp	Frequency
Max 2,6A, 625W/gang	ZigBee Hub 2,4G
LED Lamp	Motor
Max 1,67A, 400W/gang	Max 2,6A,625W/gang
Zigbee version Model NO	Zigbee version Model NO
1 Gang Touch Zigbee Switch, SWS1TZ-WHITE	1 Gang Touch Zigbee Switch, SWS1TZ-BLACK
2 Gang Touch Zigbee Switch, SWS2TZ-WHITE	2 Gang Touch Zigbee Switch, SWS2TZ-BLACK
3 Gang Touch Zigbee Switch, SWS3TZ-WHITE	3 Gang Touch Zigbee Switch, SWS3TZ-BLACK
4 Gang Touch Zigbee Switch, SWS4TZ-WHITE	4 Gang Touch Zigbee Switch, SWS4TZ-BLACK
5 Gang Touch Zigbee Switch, SWS5TZ-WHITE	5 Gang Touch Zigbee Switch, SWS5TZ-BLACK
6 Gang Touch Zigbee Switch, SWS6TZ-WHITE	6 Gang Touch Zigbee Switch, SWS6TZ-BLACK

## Warning

- 1 To prevent injury, this apparatus must be installed by a Licensed Electrical Contractor.
- 2 For indoor used only.
- 3 Please make sure the smart switch is not overloaded.
- 4 Working power cannot be higher than the rated power 10A.

## Warranty

This warranty covers defects in manufacturing that arise from the correct use of the device. It is limited to defects in materials or workmanship and does not cover damage caused by abuse, misuse, unauthorised modification, power surge damage or extreme heat or cold or corrosive environments. The warranty also does not cover the normal wear and tear on covers, cases, housings, connectors and accessories. The warranty does not apply to any product with missing, altered or defaced serial numbers. Your products come with a 24 months manufacturer's warranty as standard

The logo for SPARKELEC features a stylized starburst icon on the left, composed of several dashed lines radiating from a central point. To the right of the icon, the word "SPARKELEC" is written in a bold, black, sans-serif font. A registered trademark symbol (®) is positioned to the upper right of the final letter 'C'.

Product Manufactured &  
Distributed by Sparkelec Pty Ltd.

End